

SLALOM™*

INSTRUCTION BOOKLET



This official seal is your assurance that Nintendo has reviewed this product and that it has met our standards for excellence in workmanship, reliability and entertainment value. Always look for this seal when buying games and accessories to ensure complete compatibility with your Nintendo Entertainment System.



Thank you for selecting the Nintendo Entertainment System[®] Slalom[™]* Pak.

OBJECT OF THE GAME/GAME DESCRIPTION

One of the hottest contenders ever to come out of the starting gate. Speeding down the slope and through the flags, you dodge trees, sledders and other skiers, and can even perform freestyle stunts over the moguls. All the while, you're racing the clock to the finish line. Slalom offers 24 high-score records to challenge players on 24 exhilarating runs.

Please read this instruction booklet to ensure proper handling of your game, and then save the booklet for future reference.

1. PRECAUTIONS

- A. This is a high precision game. It should not be stored in places that are very hot or cold. Never hit it or drop it. Do not take it apart.
- B. Avoid touching the connectors. Do not get them wet or dirty. Doing so may damage the game.
- C. Do not clean with benzene, paint thinner, alcohol, or other such solvents.

NOTE: In the interest of product improvement, Nintendo Entertainment System specifications and design are subject to change without prior notice.

TM Nintendo of America Inc.

©1987 Nintendo

*©1986 Rare, Ltd.

Licensed exclusively to Nintendo of America Inc.

2. NAME OF CONTROLLER PARTS AND OPERATING INSTRUCTIONS

Controller 1 — For 1 or 2 Player Game.

Controller 2 — For Second Player in 2 Player Game.

Controller 1/Controller 2

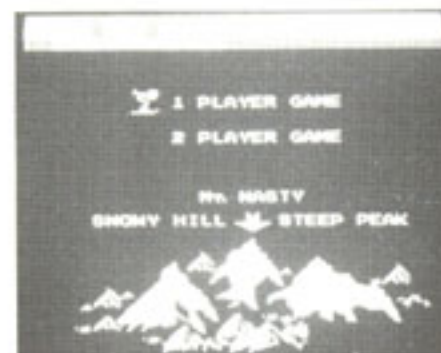
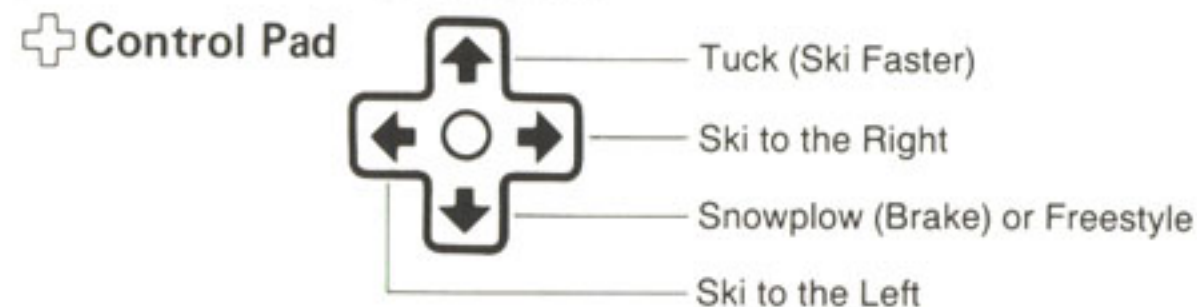
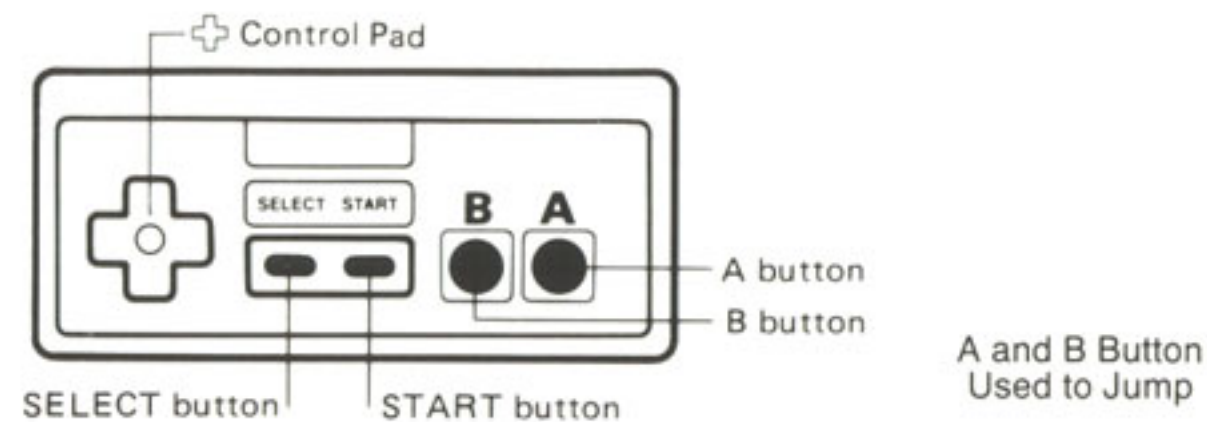

CONTROL pad:

When this is pressed, the yellow arrow (➡) moves. Line up the arrow with the mountain you wish to ski on.

Snowy Hill — Beginner

Steep Peak — Intermediate

Mt. Nasty — Expert

SELECT button:

When this button is pressed, the skier mark (🏂) moves. Line up the mark with the game you wish to play.

START button:

Press this button to begin.

Pause:

If you wish to interrupt play in the middle of a game, press the START button. The pause tone will sound and the game will stop. Press the START button again when you wish to continue playing. The game will continue from where you left off.

* Pressing either the START or SELECT button during the demonstration sequence returns you to the game menu screen.

* There are 24 high scores, one for each run.

* The high scores disappear once the power is turned off.

3. HOW TO PLAY

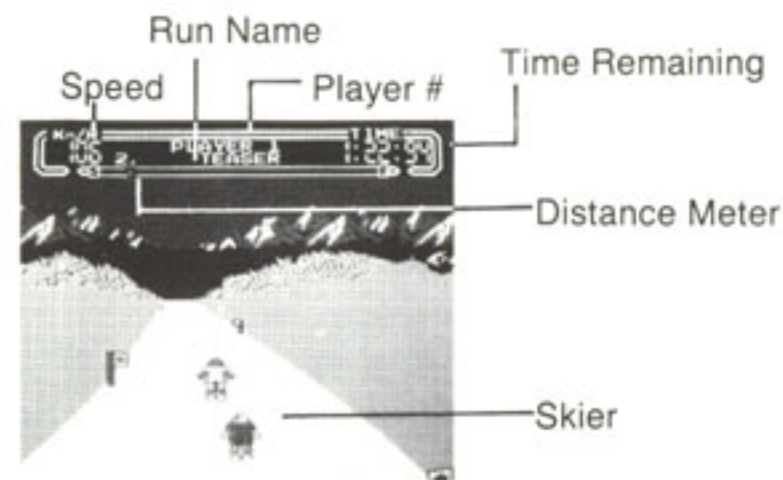

On each run, race down to the finish as fast as you can while time remains.

Ski over moguls and perform freestyle moves for solo bonus points.

Obstacles: Will cause skier to tumble and possibly fall.

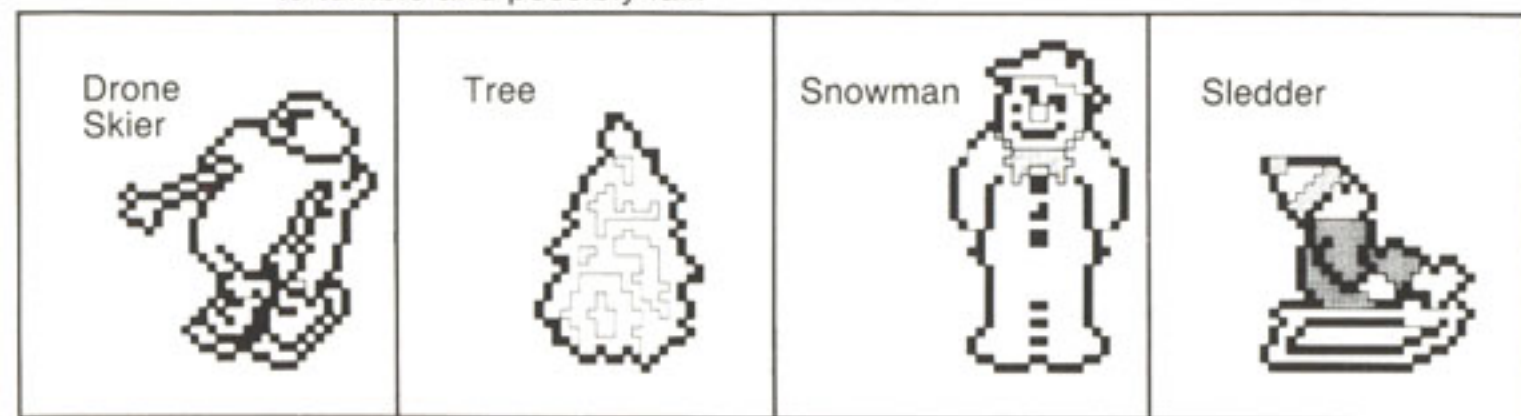

Flags:

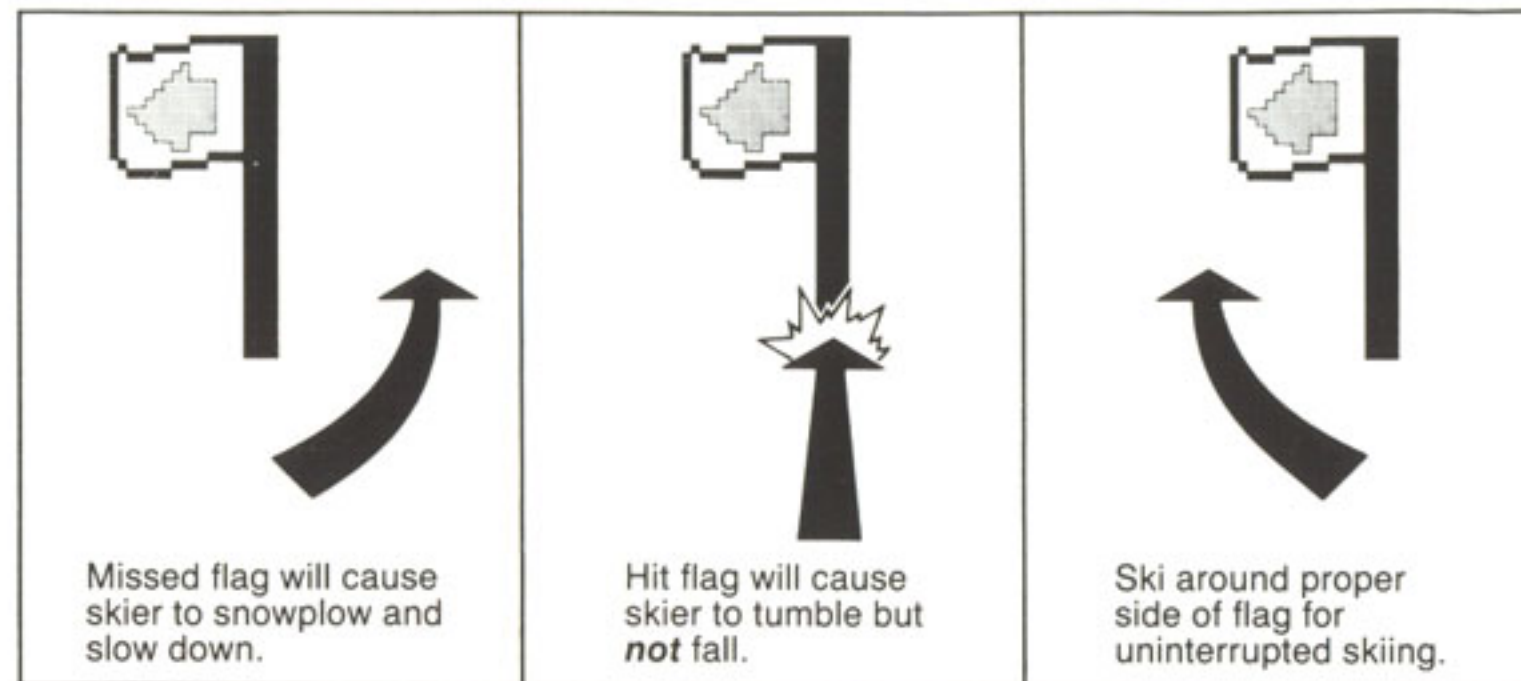

Moguls:

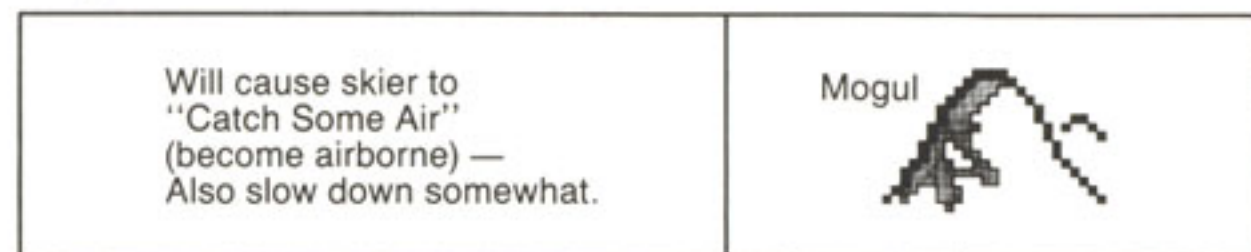

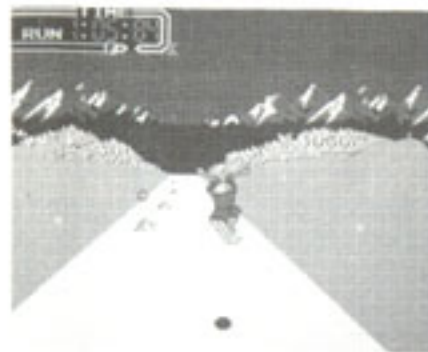

Freestyle Skiing:

By skiing over a mogul (Do not press JUMP button.) and then pressing the control pad down while airborne, you can perform freestyle tricks. The longer you hold the control pad down, the more freestyle points you earn. If you do not release the down control before you land, your ski tips will catch in the snow and you will tumble and possibly fall.



Solo Bonus Points:

Your total solo bonus is the sum of your time remaining on the clock at the completion of the last run and your freestyle points from the last run.

At the beginning of each run after the qualifying run, you receive your solo bonus points. These points are used for solo skiing — skiing alone without the bothersome drone skiers.

Example: 50 points of total solo bonus would give you 50 seconds of solo skiing commencing with the start of the current run.

COMPLIANCE WITH FCC REGULATIONS

This equipment generates and uses radio frequency energy and if not installed and used properly, that is, in strict accordance with the manufacturer's instructions, may cause interference to radio and television reception. It has been type tested and found to comply with the limits for a Class B computing device in accordance with the specifications in Subpart J of Part 15 of FCC Rules, which are designed to provide reasonable protection against such interference in a residential installation. However, there is no guarantee that interference will not occur in a particular installation. If this equipment does cause interference to radio or television reception, which can be determined by turning the equipment off and on, the user is encouraged to try to correct the interference by one or more of the following measures:

- Reorient the receiving antenna
- Relocate the NES with respect to the receiver
- Move the NES away from the receiver
- Plug the NES into a different outlet so that Control Deck and receiver are on different circuits.

If necessary, the user should consult the dealer or an experienced radio/television technician for additional suggestions. The user may find the following booklet prepared by the Federal Communications Commission helpful:

How to Identify and Resolve Radio-TV Interference Problems.

This booklet is available from the U.S. Government Printing Office, Washington, D.C. 20402, Stock No. 004-000-00345-4.

90-DAY LIMITED WARRANTY NINTENDO GAME PAKS

90-DAY LIMITED WARRANTY:

Nintendo of America Inc. ("Nintendo") warrants to the original consumer purchaser that this Nintendo Game Pak ("PAK") shall be free from defects in material and workmanship for a period of 90 days from date of purchase if a defect covered by this warranty occurs during this 90-day warranty period, Nintendo will repair or replace the PAK, at its option, free of charge.

To receive this warranty service:

1. DO NOT return your defective Game Pak to the retailer.
2. Notify the Nintendo Consumer Service Department of the problem requiring warranty service by calling: 1-800-422-2602.
Our Consumer Service Department is in operation from 6:00 A.M. to 6:00 P.M. Pacific Time, Monday through Saturday. Please Do Not send your Pak to Nintendo before calling the Consumer Service Department.
3. If the Nintendo Service Representative is unable to solve the problem by phone, you will be provided with a Return Authorization number. Simply record this number on the outside packaging of your defective PAK, and return your PAK **FREIGHT PREPAID AND INSURED FOR LOSS OR DAMAGE**, together with your sales slip or similar proof-of-purchase within the 90-day warranty period to:

Nintendo of America Inc.
NES Consumer Service Department
4820-150th Avenue N.E.
Redmond, WA 98052

This warranty shall not apply if the PAK has been damaged by negligence, accident, unreasonable use, modification, tampering, or by other causes unrelated to defective materials or workmanship.

REPAIR/SERVICE AFTER EXPIRATION OF WARRANTY:

If the PAK develops a problem requiring service after the 90-day warranty period, you may contact the Nintendo Consumer Service Department at the phone number noted at left. If the Nintendo Service Representative is unable to solve the problem by phone, you will be advised of the approximate cost for Nintendo to repair or replace the PAK and will be given a Return Authorization number.

You may then record this number on the outside packaging of the defective PAK and return the defective merchandise, **FREIGHT PREPAID AND INSURED FOR LOSS OR DAMAGE**, to Nintendo, and enclose a money order payable to Nintendo of America Inc. for the cost quoted you. (Repairs may also be charged on a VISA or MASTERCARD credit card.)

If after personal inspection, the Nintendo Service Representative determines the PAK cannot be repaired, it will be returned and your payment refunded.

WARRANTY LIMITATIONS:

ANY APPLICABLE IMPLIED WARRANTIES, INCLUDING WARRANTIES OF MERCHANTABILITY AND FITNESS FOR A PARTICULAR PURPOSE, ARE HEREBY LIMITED TO NINETY DAYS FROM THE DATE OF PURCHASE AND ARE SUBJECT TO THE CONDITIONS SET FORTH HEREIN. IN NO EVENT SHALL NINTENDO BE LIABLE FOR CONSEQUENTIAL OR INCIDENTAL DAMAGES RESULTING FROM THE BREACH OR ANY EXPRESS OR IMPLIED WARRANTIES.

The provisions of this warranty are valid in the United States only. Some states do not allow limitations on how long an implied warranty lasts or exclusion of consequential or incidental damages, so the above limitations and exclusion may not apply to you. This warranty gives you specific legal rights, and you may also have other rights which vary from state to state.



Nintendo of America Inc.
P.O. Box 957, Redmond, WA 98073-0957 U.S.A.

PRINTED IN JAPAN