

FOOTBALL

GAME PROGRAM™

INSTRUCTIONS

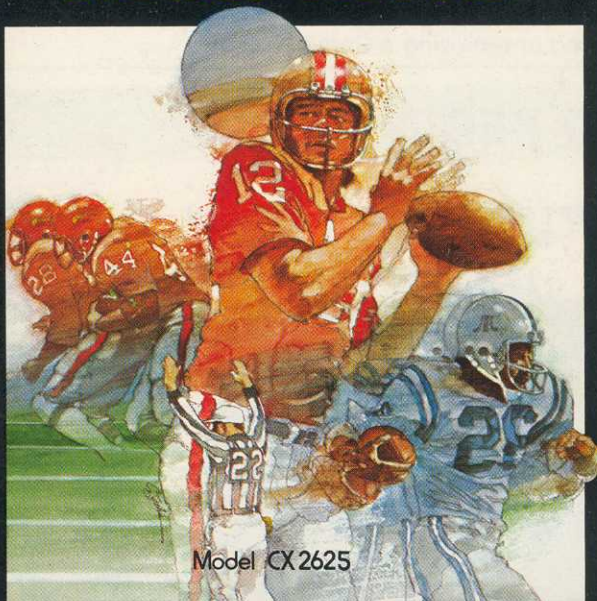

Model CX2625



 A Warner Communications Company

ATARI, INC., Consumer Division
1195 Borregas Ave., Sunnyvale, CA 94086

Use your Joystick Controllers with this Game Program™. Be sure the controller cable is firmly plugged into the jacks on the rear of your Video Computer System™. See Section 3 of your owner's manual for details. Hold the controller with the red button to your upper left towards the television screen.



Note: To prolong the life of your console unit and protect the electronic components, the unit should be OFF when inserting or removing a Game Program.

TO BEGIN PLAY

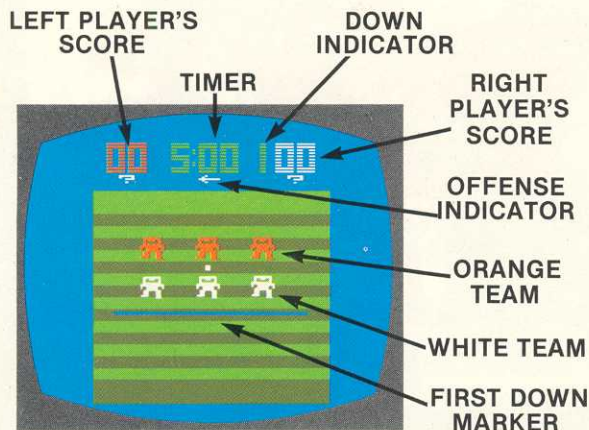

The Timer Clock at the top center of the playfield begins counting down from 5:00. The clock ticks only during play and stops between plays. Depress the **game reset** switch to start a new game.

The left, or orange, player begins on offense. This is indicated by the small arrow under the Timer Clock. The number at top left is the orange player's score. The number at top right is the white player's score. The number to the left of the white player's score is the Down Indicator.

The question mark (?) beneath each player's score is a reminder to program your play, and will disappear when you do so. The play automatically begins after both players have entered a play formation.

The offensive player has four "downs" or attempts to get the ball over the First Down Marker or the line shown on the screen. If the offense moves the ball over the First Down Marker, he receives another four downs. If the player scores, his opponent receives the ball and becomes the offensive team.

To stop your opponent from getting a first down or scoring, you must "tackle" him by stopping his forward motion. Do this by maneuvering one of your players into his path and touching him.

USING THE CONTROLLER

There are five offensive and five defensive formations. Use your Joystick to program the formation you wish to use (see diagrams on back pages). For a punt formation push the red controller button.

After the play begins, each player (in games 1 and 2) can control his men with the Joystick (Diagram refers to movement as you see it on your television screen). The offensive player controls only the ball carrier and can pass, (or punt from the punt formation), by pressing the red controller button.

The defensive player controls his lineman with the joystick, and when the red controller button is pressed, controls the defensive back.

All offensive plays can be pass plays, except when a "punt" play is set. Any player (including your opponent) is an eligible receiver. All passes must be made behind the "line of scrimmage" or the line on which the play started.

To punt, push the red controller button and leave the joystick in the neutral position. After the play starts, push

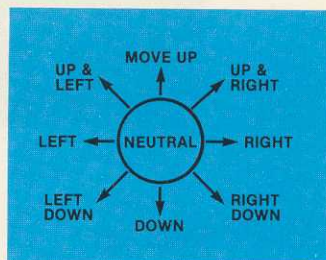

the red button again and your Quarterback will kick the ball. On a punt play only the defensive back can catch and return the ball. If the ball is not caught, the computer will randomly select the yardage or length of your kick.

In games 1 and 2, the path of the ball on a pass or kick can be "steered" after it leaves the Quarterback by using the Joystick. You can steer the ball left or right only.

SCORING

The offensive team scores a "touchdown" (seven points) by moving the ball past the opponent's goal line. The defensive team can score a "safety" (two points) by tackling the opponent behind his goal line. In addition, the defensive team gets the ball.

HANDICAP (Difficulty Switches)

When placed in the **a** position your players cannot move from side to side as quickly as in the **b** position. This will give the more experienced player a handicap.

GAME DESCRIPTIONS

GAME 1 - After programming your play, use the Joystick to control your players. The offensive player controls only the ball carrier and the flight of the pass or kick. The defensive player controls his lineman or, by holding the red controller button down, the defensive back.

The players will randomly follow the play as programmed when not controlled by your Joystick.

GAME 2 - In this game, when your players are not controlled by the Joystick, they will follow the play exactly as programmed. Use more strategy and try to outguess your opponent's plays.

GAME 3 - Program in your offensive and defensive plays and watch the computer run them out. Neither player can control the players movements, but the offense can pass or kick the ball by pushing the red controller button.

OFFENSIVE PLAYS

- 1 SPLIT LEFT
- 2 TIGHT RIGHT
- 3 SPLIT RIGHT
- 4 TIGHT LEFT
- 5 PUNT

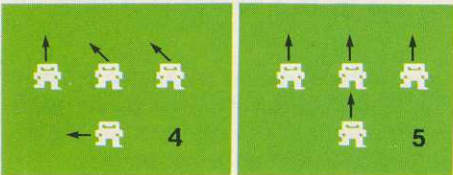
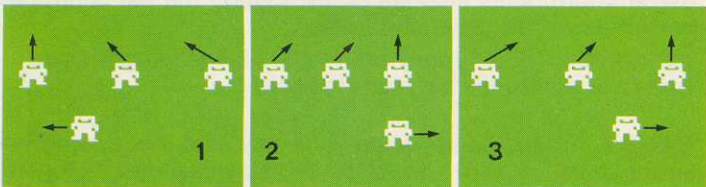
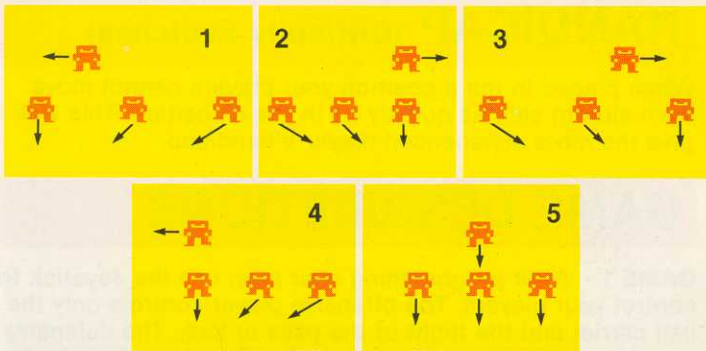
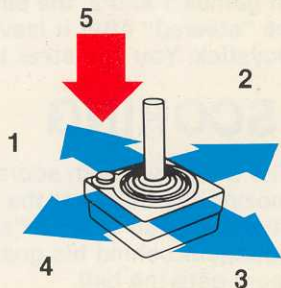

Right and left refers to how the teams are viewed on the playfield.

DEFENSIVE PLAYS

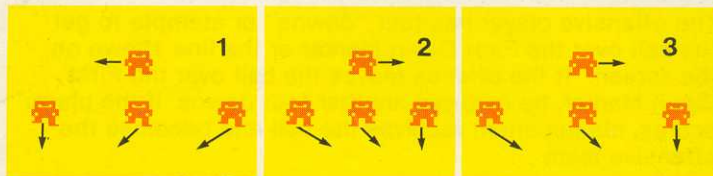

Right and left refers to how the teams are viewed on the playfield.

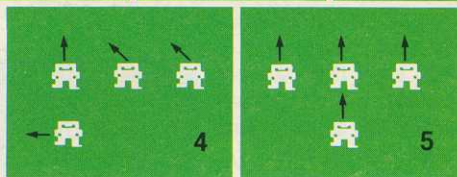
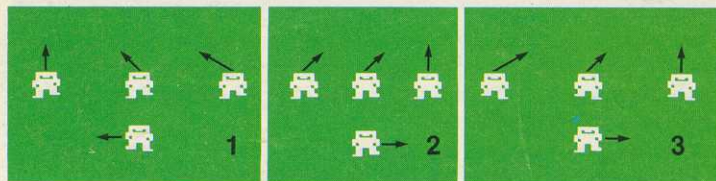
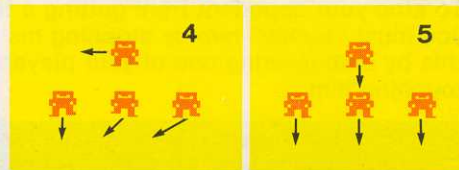

- 1 WIDE LEFT
- 2 TIGHT RIGHT
- 3 WIDE RIGHT
- 4 TIGHT LEFT
- 5 DEEP

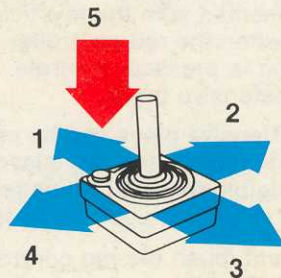

FOOTBALL

GAME PROGRAM™

INSTRUCTIONS

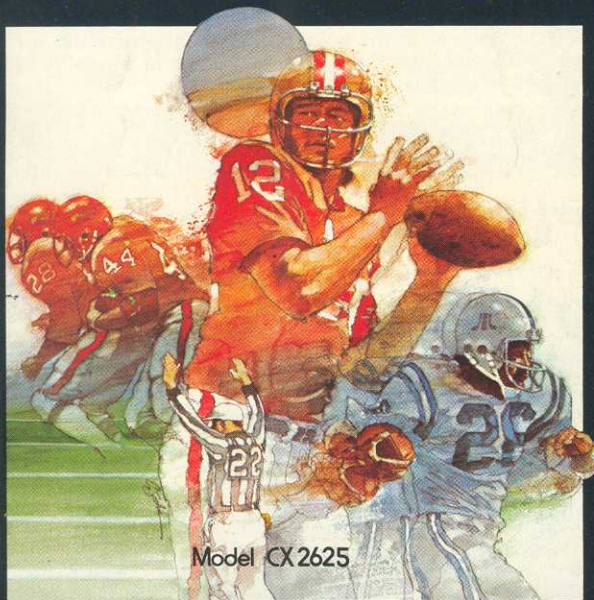

Model CX2625



A Warner Communications Company

ATARI, INC., Consumer Division
1195 Borregas Ave., Sunnyvale, CA 94086

Use your Joystick Controllers with this ATARI® Game Program.™ Be sure the Controllers are firmly plugged into the LEFT and RIGHT CONTROLLER jacks at the rear of your ATARI Video Computer System.™ Hold the Controller with the red button to your upper left toward the television screen. Use a Joystick plugged into the LEFT CONTROLLER jack for one player games.



Note: Always turn the console power switch OFF when inserting or removing an ATARI Game Program.

Note: When playing on a black and white television, place the TV type switch on the console in the color position. Otherwise the white players score will disappear from the screen at game end when the switch is in the black and white (b-w) position.

TO BEGIN PLAY

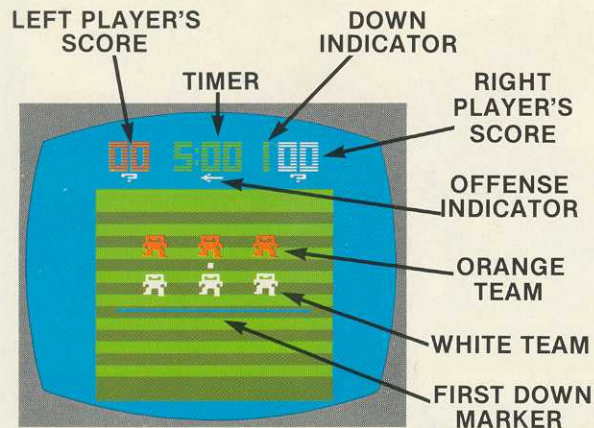

The Timer Clock at the top center of the playfield begins counting down from 5:00. The clock ticks only during play and stops between plays. Depress the **game reset** switch to start a new game.

The left, or orange, player begins on offense. This is indicated by the small arrow under the Timer Clock. The number at top left is the orange player's score. The number at top right is the white player's score. The number to the left of the white player's score is the Down Indicator.

The question mark (?) beneath each player's score is a reminder to program your play, and will disappear when you do so. The play automatically begins after both players have entered a play formation.

The offensive player has four "downs" or attempts to get the ball over the First Down Marker or the line shown on the screen. If the offense moves the ball over the First Down Marker, he receives another four downs. If the player scores, his opponent receives the ball and becomes the offensive team.

To stop your opponent from getting a first down or scoring, you must "tackle" him by stopping his forward motion. Do this by maneuvering one of your players into his path and touching him.

USING THE CONTROLLER

There are five offensive and five defensive formations. Use your Joystick to program the formation you wish to use (see diagrams on back pages). For a punt formation push the red controller button.

After the play begins, each player (in games 1 and 2) can control his men with the Joystick (Diagram refers to movement as you see it on your television screen). The offensive player controls only the ball carrier and can pass, (or punt from the punt formation), by pressing the red controller button.

The defensive player controls his linemen with the joystick, and when the red controller button is pressed, controls the defensive back.

All offensive plays can be pass plays, except when a "punt" play is set. Any player (including your opponent) is an eligible receiver. All passes must be made behind the "line of scrimmage" or the line on which the play started.

To punt, push the red controller button and leave the joystick in the neutral position. After the play starts, push

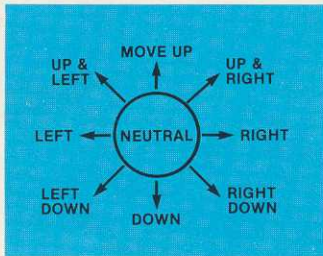

the red button again and your Quarterback will kick the ball. On a punt play only the defensive back can catch and return the ball. If the ball is not caught, the computer will randomly select the yardage or length of your kick.

In games 1 and 2, the path of the ball on a pass or kick can be "steered" after it leaves the Quarterback by using the Joystick. You can steer the ball left or right only.

SCORING

The offensive team scores a "touchdown" (seven points) by moving the ball past the opponent's goal line. The defensive team can score a "safety" (two points) by tackling the opponent behind his goal line. In addition, the defensive team gets the ball.

HANDICAP (Difficulty Switches)

When placed in the **a** position your players cannot move from side to side as quickly as in the **b** position. This will give the more experienced player a handicap.

GAME DESCRIPTIONS

GAME 1 - After programming your play, use the Joystick to control your players. The offensive player controls only the ball carrier and the flight of the pass or kick. The defensive player controls his linemen or, by holding the red controller button down, the defensive back.

The players will randomly follow the play as programmed when not controlled by your Joystick.

GAME 2 - In this game, when your players are not controlled by the Joystick, they will follow the play exactly as programmed. Use more strategy and try to outguess your opponent's plays.

GAME 3 - Program in your offensive and defensive plays and watch the computer run them out. Neither player can control the players movements, but the offense can pass or kick the ball by pushing the red controller button.

OFFENSIVE PLAYS

- 1 SPLIT LEFT
- 2 TIGHT RIGHT
- 3 SPLIT RIGHT
- 4 TIGHT LEFT
- 5 PUNT

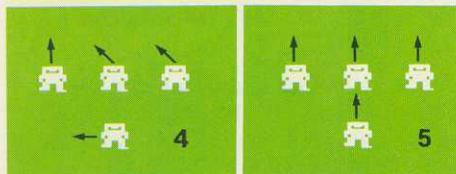
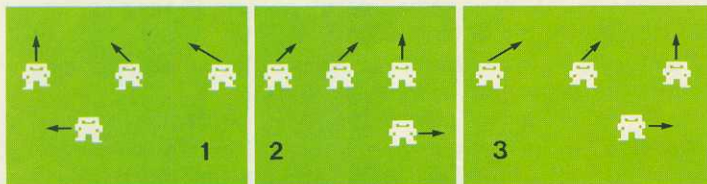
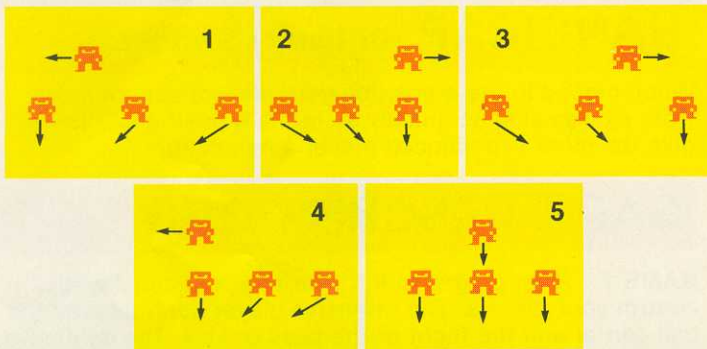
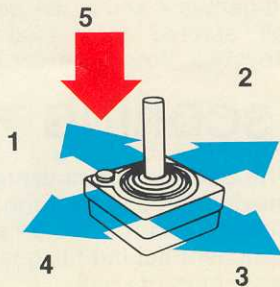

Right and left refers to how the teams are viewed on the playfield.

DEFENSIVE PLAYS

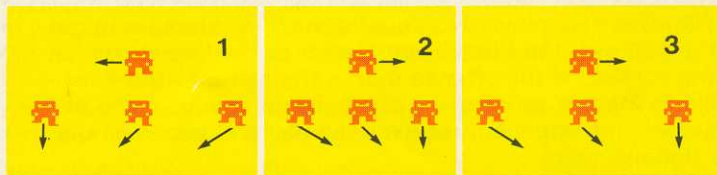

Right and left refers to how the teams are viewed on the playfield.

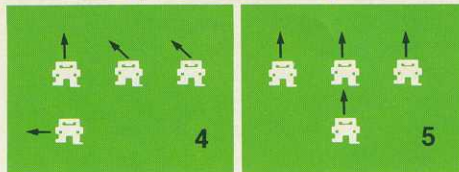
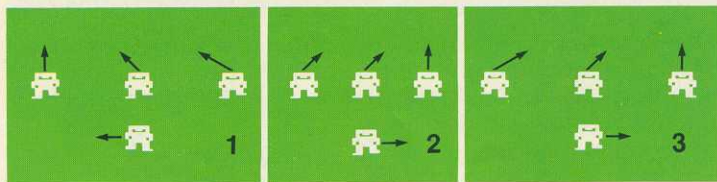
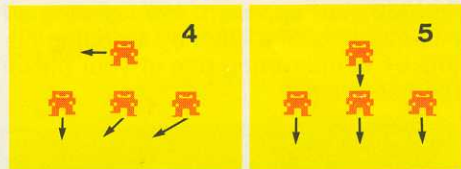

- 1 WIDE LEFT
- 2 TIGHT RIGHT
- 3 WIDE RIGHT
- 4 TIGHT LEFT
- 5 DEEP

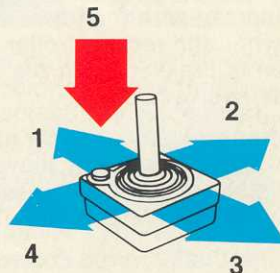

FOOTBALL

ATARI® GAME PROGRAM™ INSTRUCTIONS

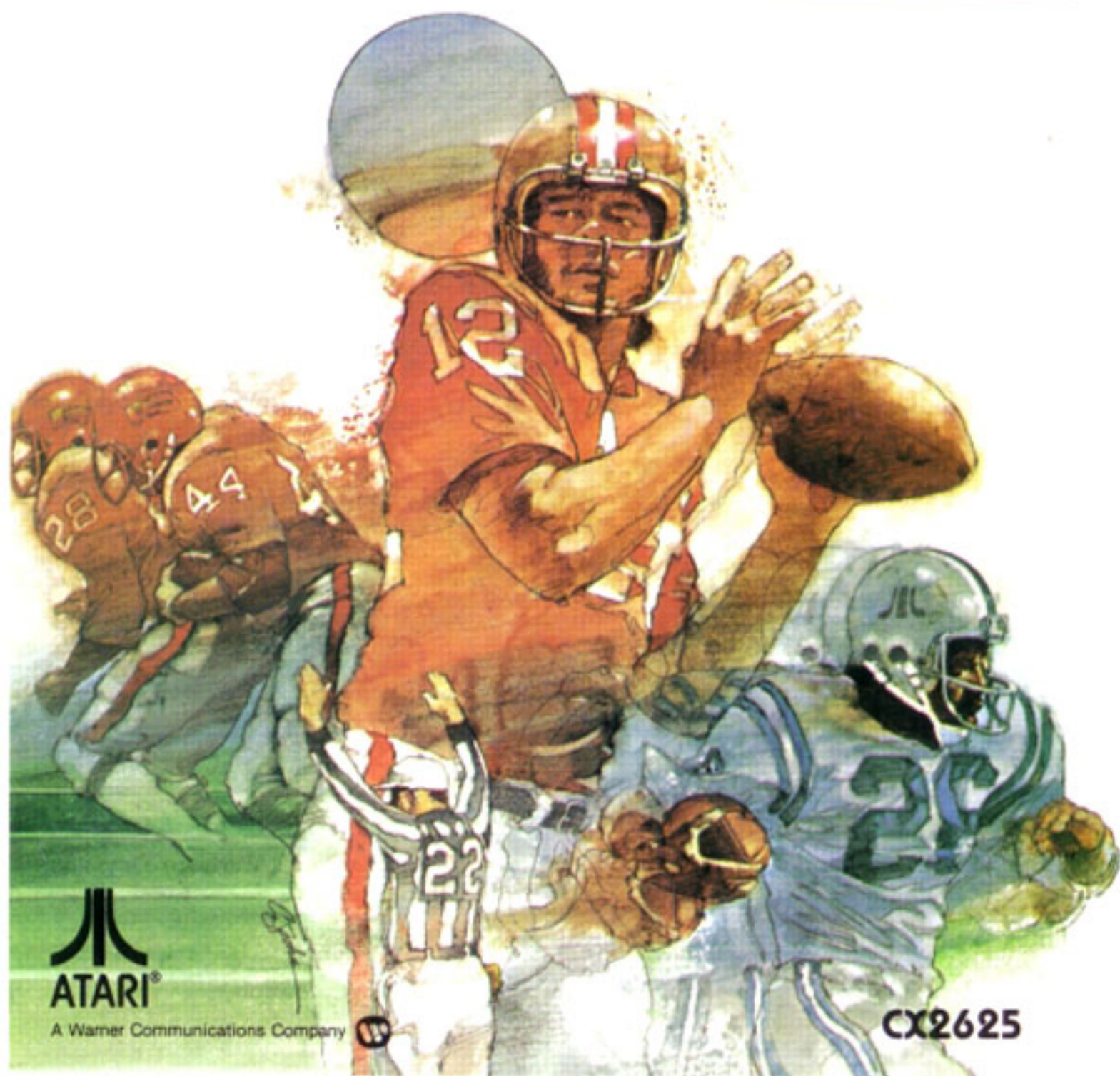

A Warner Communications Company



CX2625

COMPLETE
GAME PLAY
INSTRUCTIONS

TWO-PLAYER
GAMES

GAME VARIATIONS
Section 5

TABLE OF CONTENTS

1. GAME PLAY	1
2. USING THE CONTROLLERS	2
3. CONSOLE CONTROLS	3
4. SCORING	3
5. GAME VARIATIONS	4
6. OFFENSIVE PLAYS	5
7. DEFENSIVE PLAYS	7

NOTE: Always turn the console power switch off when inserting or removing an ATARI® Game Program™ cartridge. This will protect the electronic components and prolong the life of your ATARI Video Computer System™ game. Manual, Program, and Audiovisual © 1978 ATARI, INC.

1. GAME PLAY

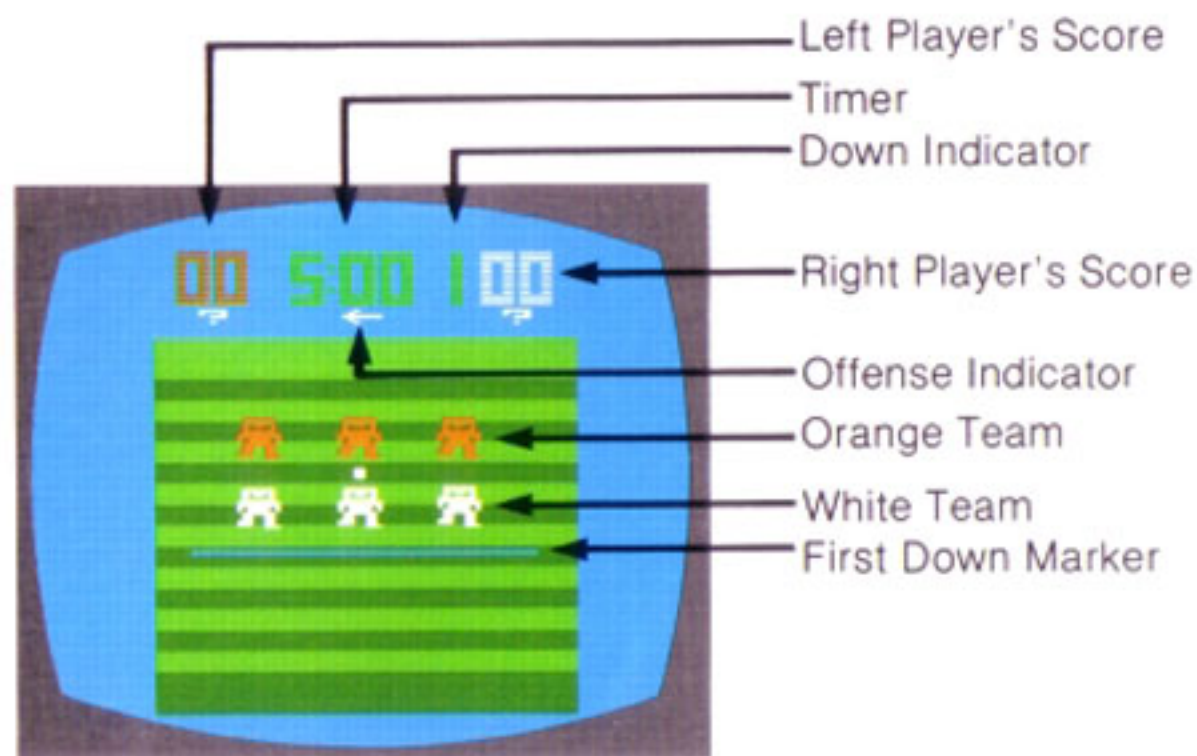

At the beginning of a game, the Timer Clock at the top center of the playfield begins counting down from 5:00. The clock ticks only during play and stops between plays. Press **game reset** to start a new game.

The left, or orange, player begins on offense. This is indicated by the small arrow under the Timer Clock. The number at top left is the orange player's score. The number at top right is the white player's score. The number to the left of the white player's score is the Down Indicator.

The question (?) beneath each player's score is a reminder to program your play, and will disappear

when you do so. The play automatically begins after both players have entered a play formation.

The offensive player has four "downs" or attempts to get the ball over the First Down Marker or the line shown on the screen. If the offense moves the ball over the First Down Marker, he receives another four downs. If the player scores, his opponent receives the ball and becomes the offensive team.

To stop your opponent from getting a first down or from scoring, you must "tackle" him by stopping his forward motion. Do this by maneuvering one of your players into his path and touching him.

2. USING THE CONTROLLERS

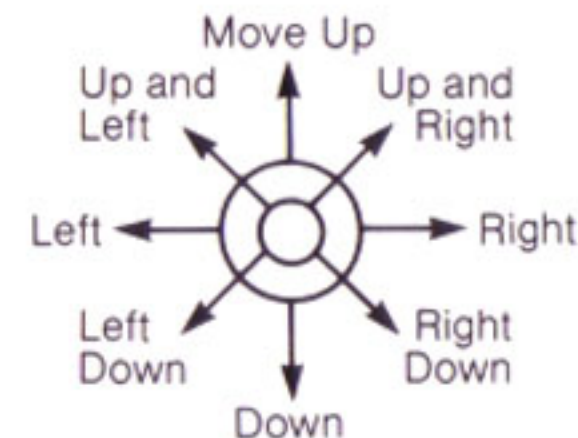

Use your Joystick Controllers with this ATARI® Game Program™ cartridge. Be sure the Joystick Controller cables are firmly plugged into the **RIGHT** and **LEFT CONTROLLER** jacks at the back of your ATARI Video Computer System™ game. Hold the Joystick with the red button to your upper left, toward the television screen. See *Section 3 of your owner's manual for further details.*

There are five offensive and five defensive formations. Use your Joystick to program the formation you wish to use (see **OFFENSIVE and DEFENSIVE PLAYS** sections). For a punt formation push the red controller button.

After the play begins, each player (in **GAME 1** and **2**) can control his men with the Joystick (Diagram refers to movement as you see it on your television screen). The offensive player controls only the ball carrier and can pass, (or punt from the punt formation), by pressing the red controller button.

The defensive player controls his

lineman with the Joystick, and when the red controller button is pressed, controls the defensive back.

All offensive plays can be pass plays, except when a "punt" play is set. Any player (including your opponent) is an eligible receiver. All passes must be made behind the "line of scrimmage" or the line on which the play started.

To punt, push the red controller button and leave the Joystick in the neutral position. After the play starts, push the red button again and your Quarterback will kick the ball. On a punt play only the defensive back can catch and return the ball. If the ball is not caught, the computer will randomly select the yardage or length of your kick.

In **GAMES 1** and **2**, the path of the ball on a pass or kick can be "steered" after it leaves the Quarterback by using the Joystick. You can steer the ball left or right only.

3. CONSOLE CONTROLS

GAME SELECT SWITCH

Use this switch to select the game number you wish to play. The game number appears at the upper left corner of the screen. (See **GAME VARIATIONS** for game numbers.)

GAME RESET SWITCH

Use this switch to start game play or to reset a game at any time. If the game number is on the screen when the game reset switch is pressed, the game number will disappear to make room for the player's scores.

DIFFICULTY SWITCHES

When placed in the **a** position your players cannot move from side to side as quickly as in the **b** position. This will give the more experienced player a handicap.

TV TYPE SWITCH

Set this switch to **color** if you have a color television set. Set it to **b-w** if you are playing the game in black and white.

4. SCORING

The offensive team scores a "touchdown" (seven points) by moving the ball past the opponent's goal line. The defensive team can score a "safety" (two points) by tackling the opponent behind his goal line. In addition, the defensive team gets the ball, after a safety is scored.

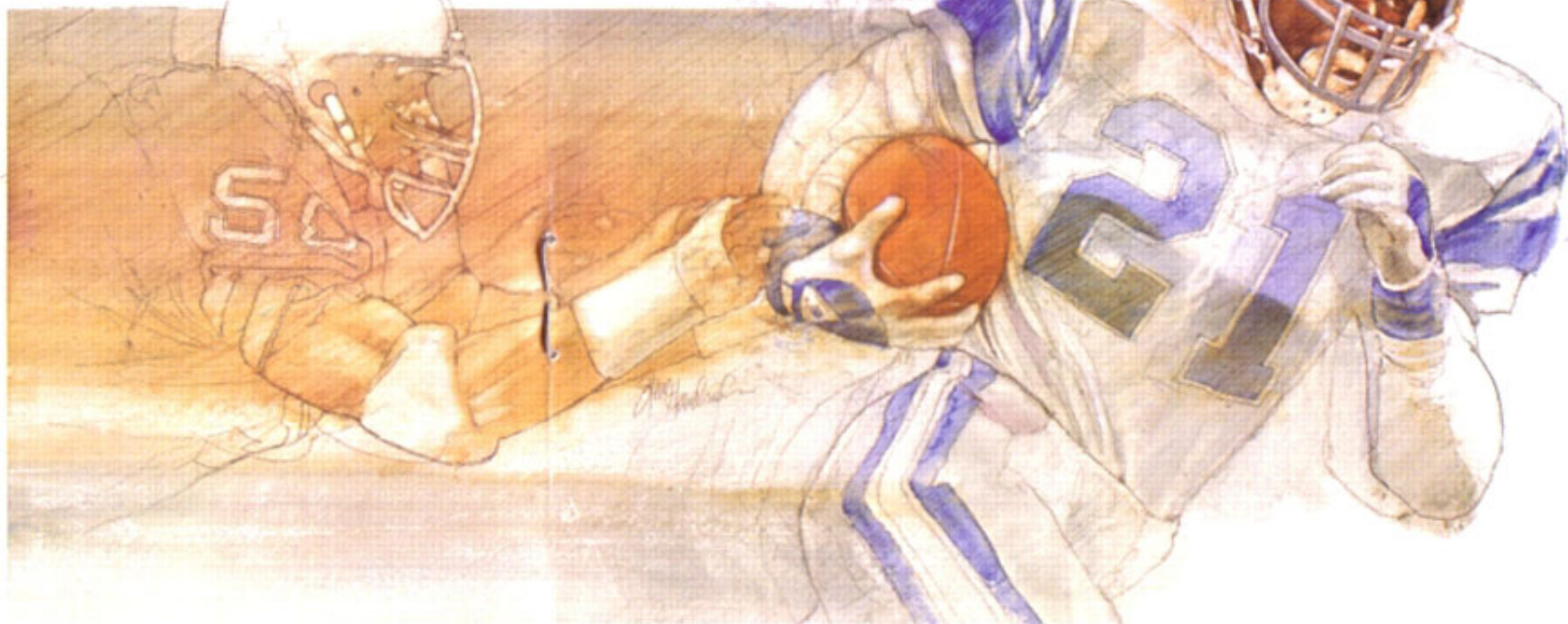

5. GAME VARIATIONS

GAME 1 - After programming your play, use the Joystick to control your players. The offensive player controls only the ball carrier and the flight of the pass or kick. The defensive player controls his lineman or, by holding the red controller button down, the defensive back.

The players will randomly follow the play as programmed when not controlled by your Joystick.

GAME 2 - In this game, when your players are not controlled by the Joystick, they will follow the play exactly as programmed. Use more strategy and try to outguess your opponent's plays.

GAME 3 - Program in your offensive and defensive plays and watch the computer run them out. Neither player can control the players' movements, but the offense can pass or kick the ball by pushing the red controller button.

6. OFFENSIVE PLAYS

- 1 SPLIT LEFT
- 2 TIGHT RIGHT
- 3 SPLIT RIGHT
- 4 TIGHT LEFT
- 5 PUNT

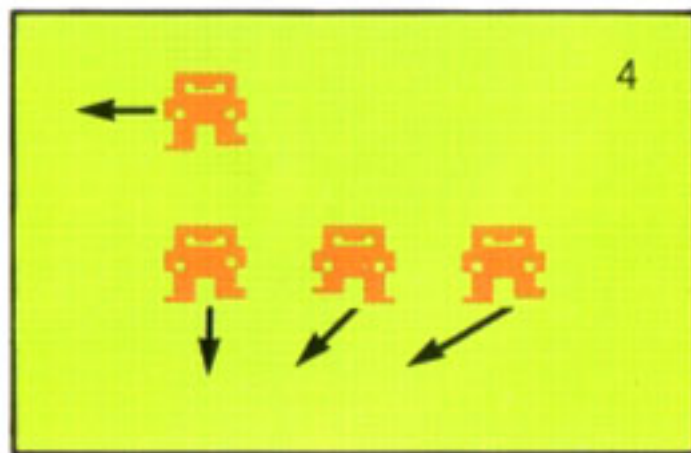
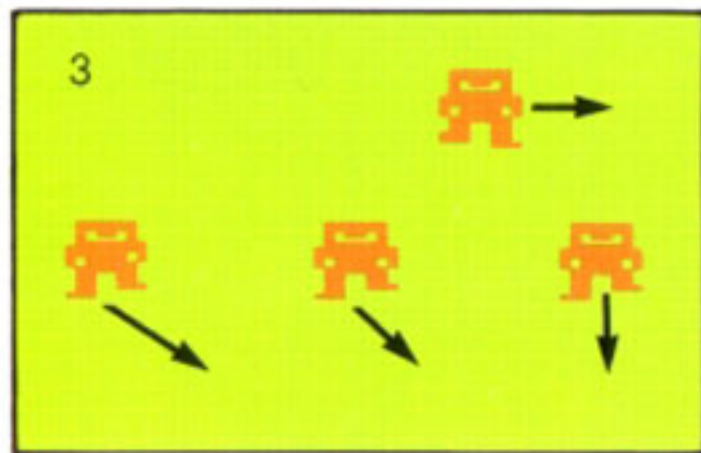
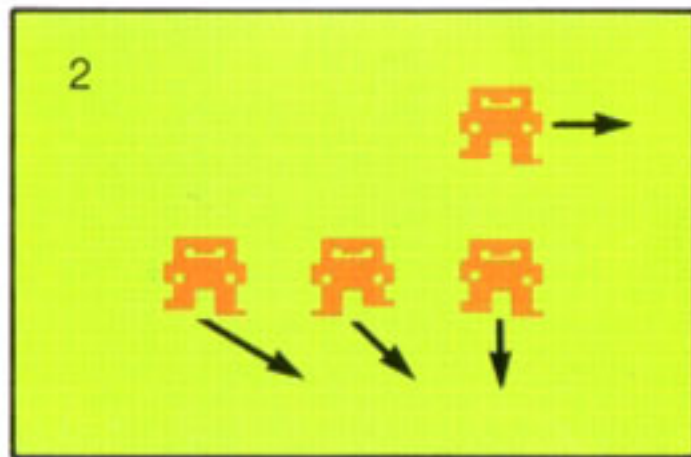
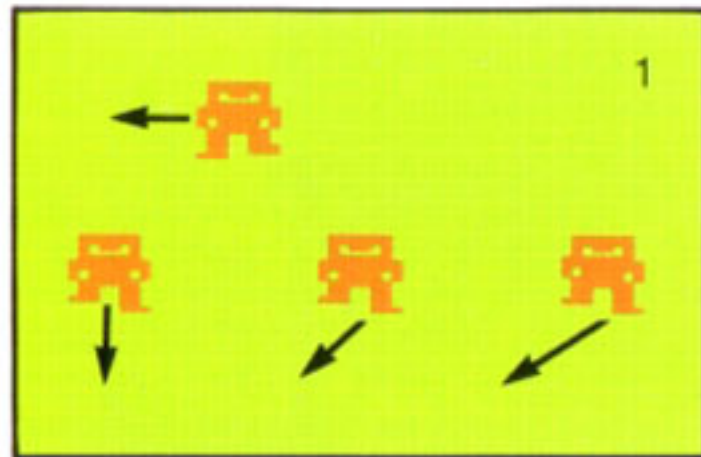
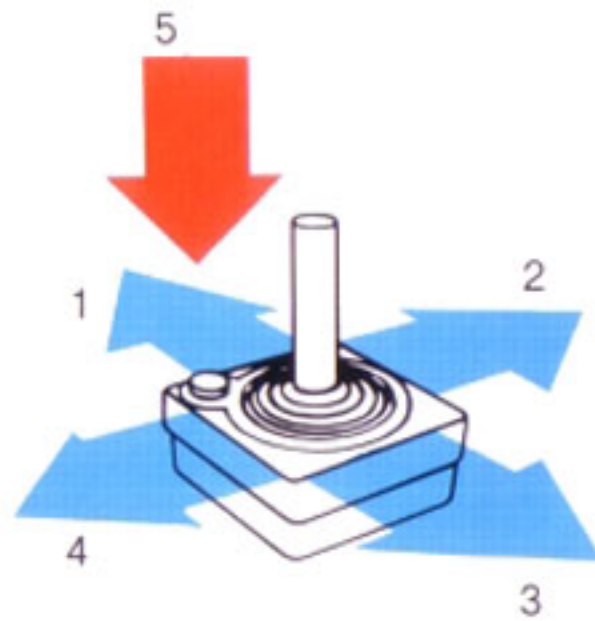

Right and left refers to how the teams are viewed on the playfield.

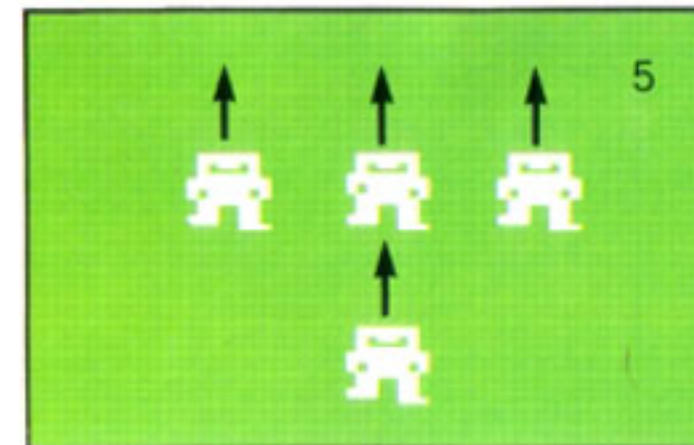
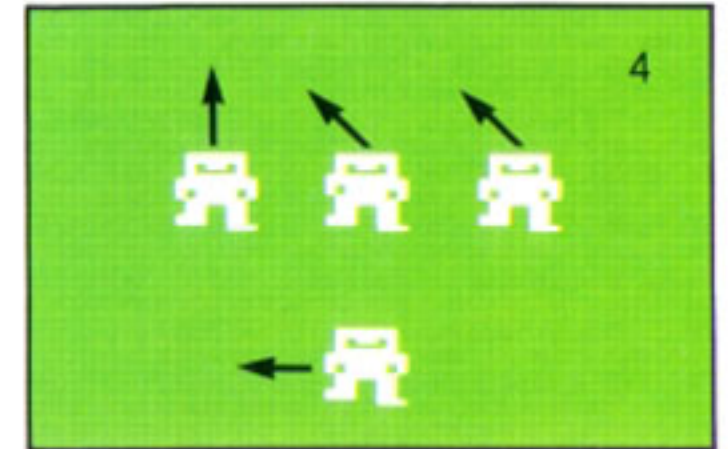
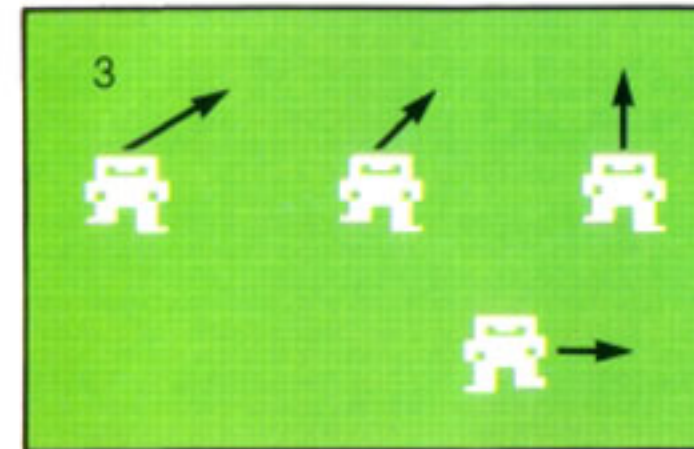
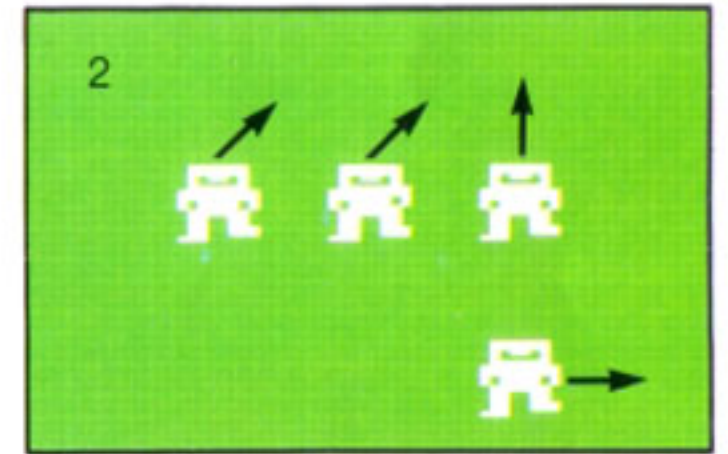
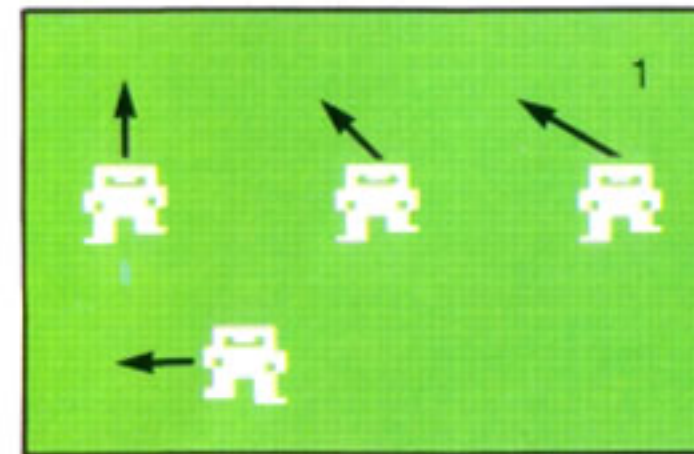
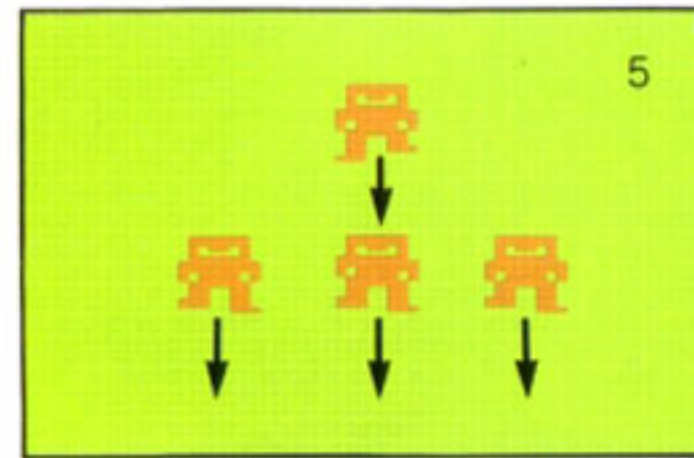

7. DEFENSIVE PLAYS

- 1 WIDE LEFT
- 2 TIGHT RIGHT
- 3 WIDE RIGHT
- 4 TIGHT LEFT
- 5 DEEP

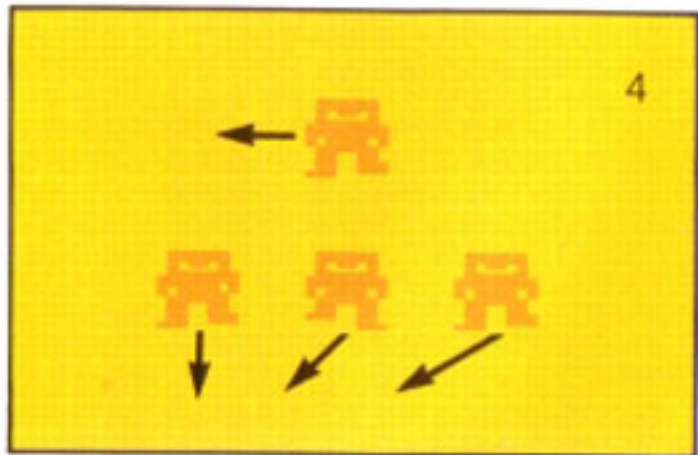
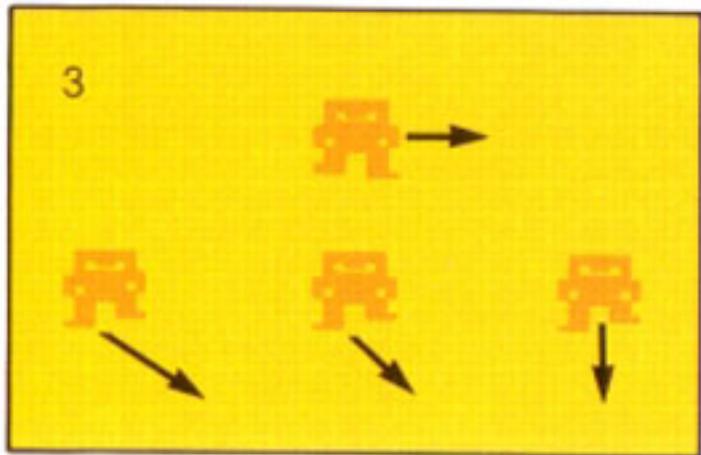
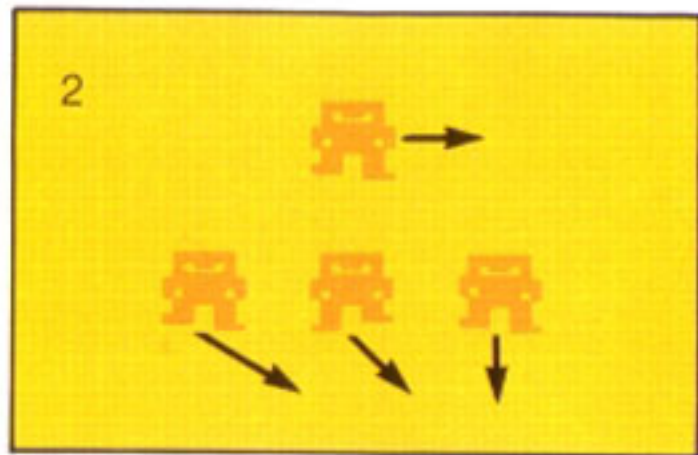
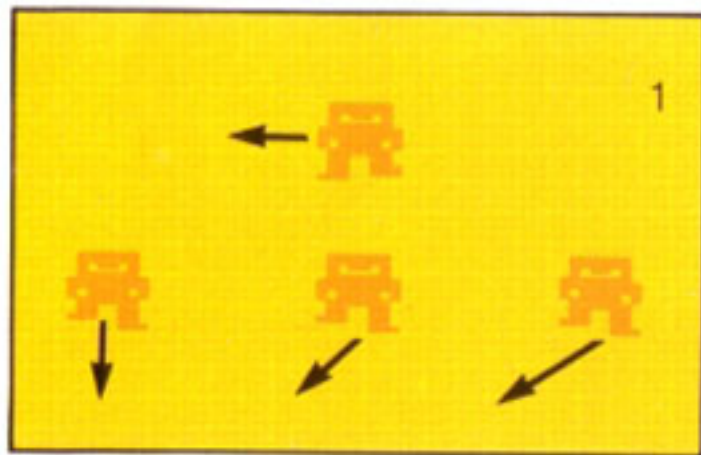
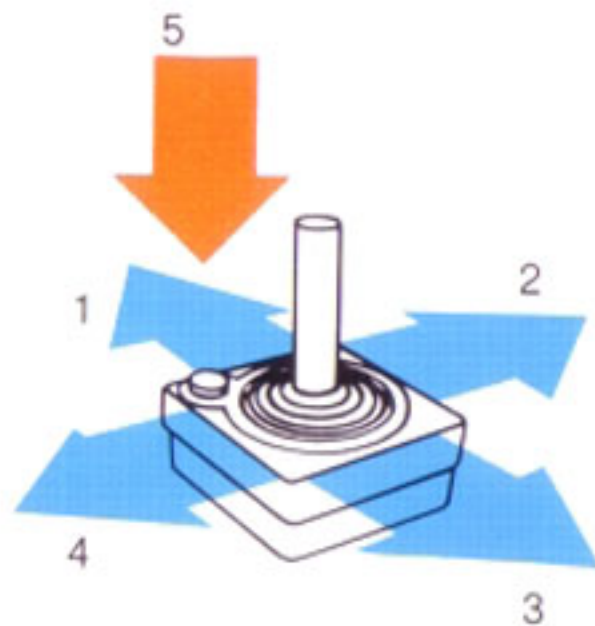

Right and left refers to how the teams are viewed on the playfield.

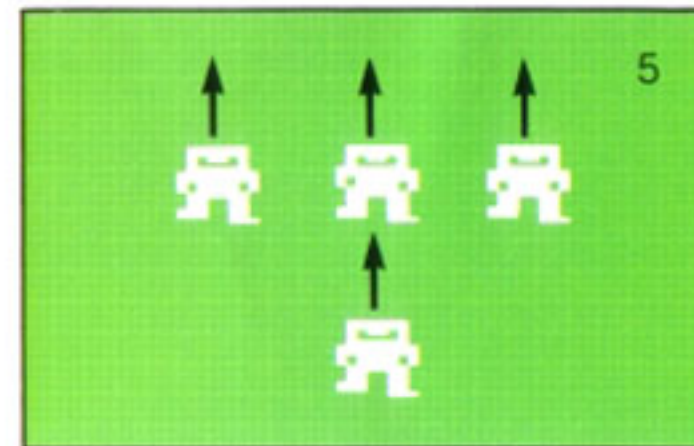
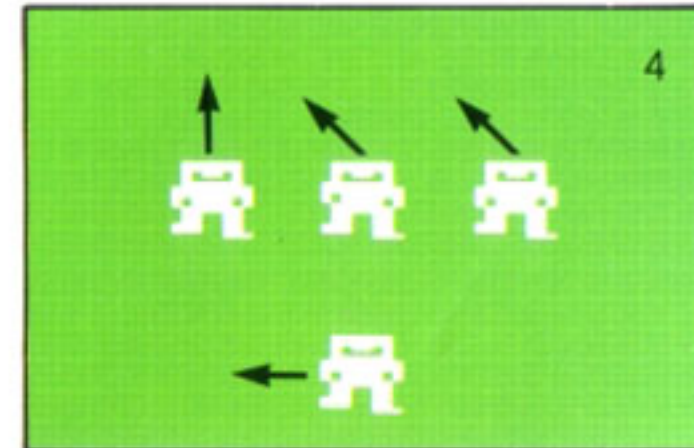
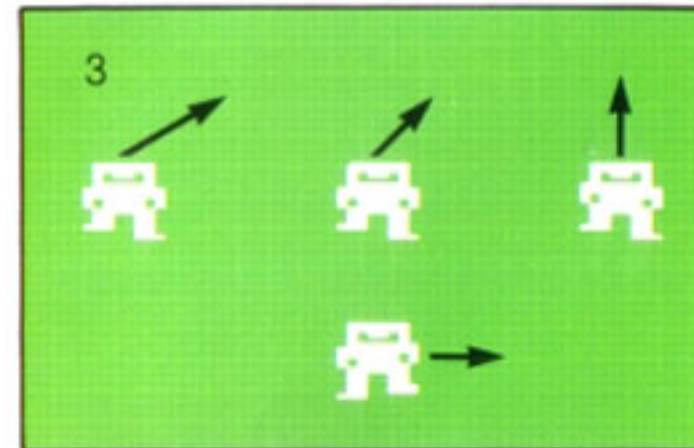
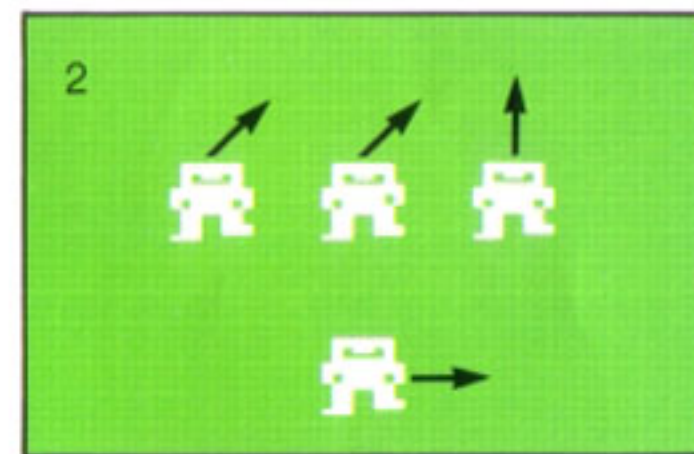
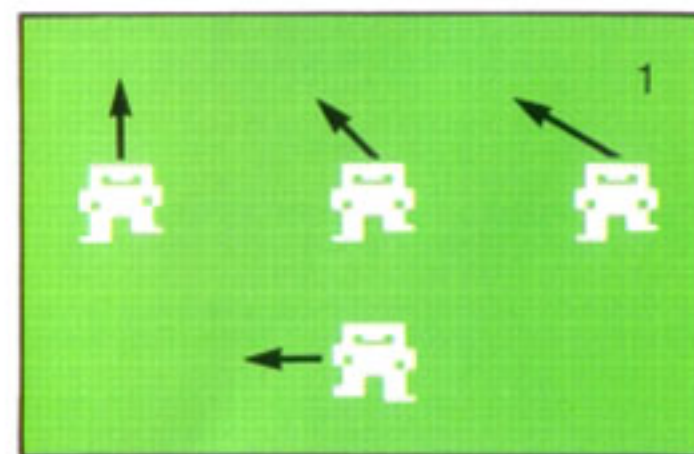
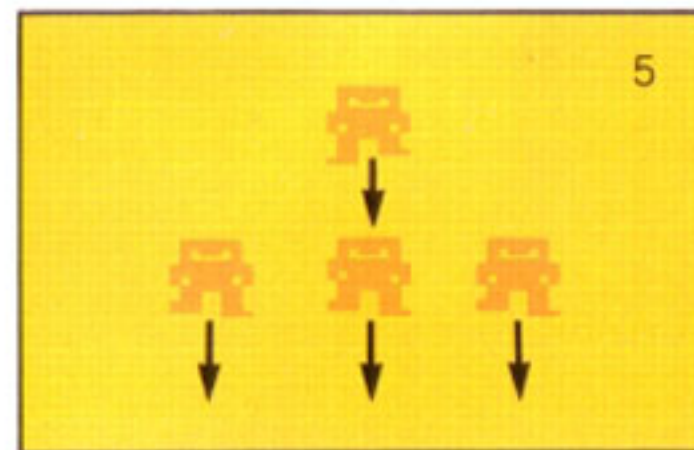

GAME PROGRAM™ CARTRIDGE LIMITED NINETY DAY WARRANTY

ATARI, INC. ("Atari") warrants to the original consumer purchaser that your ATARI® Game Program cartridge is free from any defects in material or workmanship for a period of ninety days from the date of purchase. If any such defect is discovered within the warranty period, Atari's sole obligation will be to replace the cartridge free of charge on receipt of the cartridge (charges prepaid, if mailed or shipped) with proof of date of purchase at either the retail store where the cartridge was purchased or at one of the ATARI Regional Service Centers listed below:

Atari, Inc.
1312 Crossman Ave.
Sunnyvale, CA 94086

Atari, Inc.
5400 Newport Dr.
Suite 1
Rolling Meadows, IL 60008

Atari, Inc.
43 Belmont Dr.
Somerset, NJ 08873

Atari, Inc.
2109 East Division St.
Arlington, TX 76001

This warranty shall not apply if the cartridge (i) has been misused or shows signs of excessive wear; (ii) has been damaged by being used with any products not supplied by ATARI, or (iii) has been damaged by being serviced or modified by anyone other than an ATARI Regional Service Center.

ANY APPLICABLE IMPLIED WARRANTIES, INCLUDING WARRANTIES OF MERCHANTABILITY AND FITNESS, ARE HEREBY LIMITED TO NINETY DAYS FROM THE DATE OF PURCHASE. CONSEQUENTIAL OR INCIDENTAL DAMAGES RESULTING FROM A BREACH OF ANY APPLICABLE EXPRESS OR IMPLIED WARRANTIES ARE HEREBY EXCLUDED.

Some states do not allow limitations on how long an implied warranty lasts or do not allow the exclusion or limitations of incidental or consequential damages, so the above limitations or exclusions may not apply to you.

This warranty gives you specific legal rights and you may also have other rights which vary from state to state.



A Warner Communications Company 

ATARI, INC., Consumer Division
P.O. Box 427, Sunnyvale, CA 94086